

Quadruple 2 to 1 Multiplexers

# UT54ACS157/UT54ACTS157

## Features

- 1.2 $\mu$  CMOS
  - Latchup immune
- High speed
- Low power consumption
- Single 5 volt supply
- Available QML Q or V processes
- Flexible package
  - 16-pin DIP
  - 16-lead flatpack
- UT54ACS157 - SMD 5962-96552
- UT54ACTS157 - SMD 5962-96553

## Description

The UT54ACS157 and the UT54ACTS157 are monolithic data selectors/multiplexers. A 4-bit word is selected from one of two sources and is routed to the four outputs. A separate strobe input,  $\bar{G}$ , is provided.

The devices are characterized over the full military temperature range of -55°C to +125°C.

## Function Table

Inputs				Output
Strobe $\bar{G}$	Select $\bar{A/B}$	Data		Y
		A	B	
H	X	X	X	L
L	L	L	X	L
L	L	H	X	H
L	H	X	L	L
L	H	X	H	H

## Pinouts

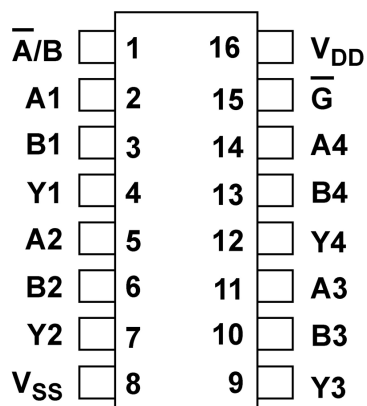

16-Pin DIP  
Top View

# UT54ACS157/UT54ACTS157

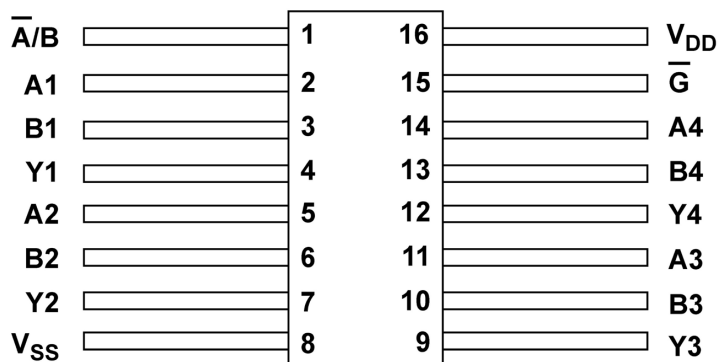

16-Lead Flatpack  
Top View

## Logic Symbol

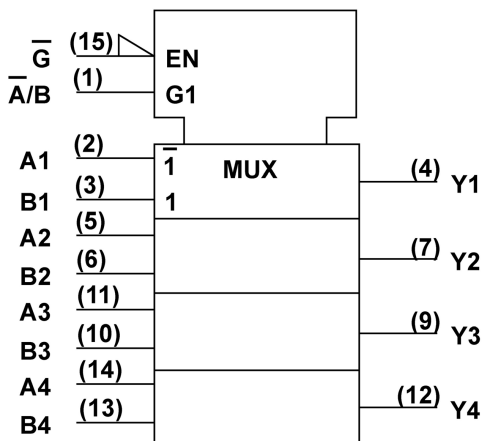

**Note:**

- 1) Logic symbol in accordance with ANSI/IEEE Std 91-1984 and IEC Publication 617-12.

# UT54ACS157/UT54ACTS157

## Logic Diagram

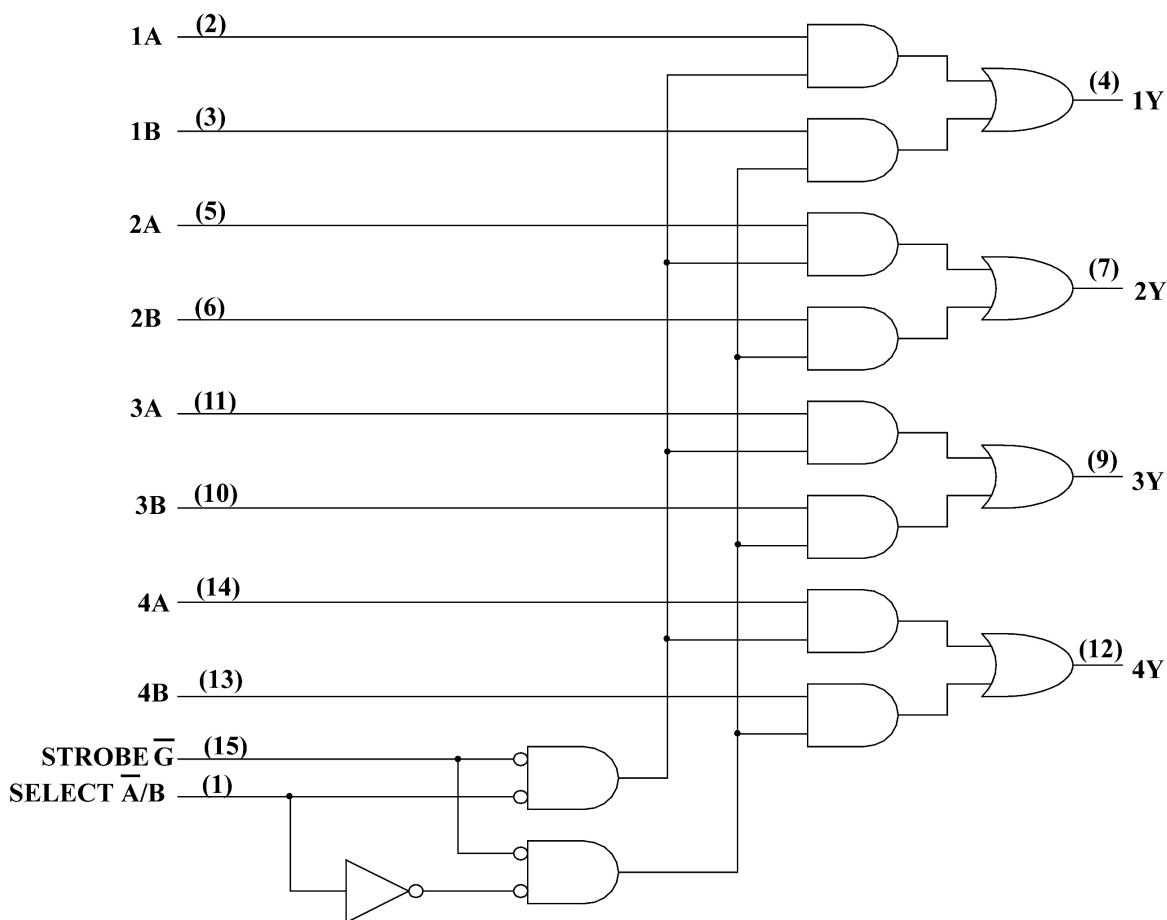

## Operational Environment <sup>1</sup>

Parameter	Limit	Units
Total Dose	1.0E6	rads(Si)
SEU Threshold <sup>2</sup>	80	MeV-cm <sup>2</sup> /mg
SEL Threshold	120	MeV-cm <sup>2</sup> /mg
Neutron Fluence	1.0E14	n/cm <sup>2</sup>

### Notes:

- 1) Logic will not latchup during radiation exposure within the limits defined in the table.
- 2) Device storage elements are immune to SEU affects.

# UT54ACS157/UT54ACTS157

## Absolute Maximum Ratings

Symbol	Parameter	Limit	Units
$V_{DD}$	Supply voltage	-0.3 to 7.0	V
$V_{I/O}$	Voltage any pin	-.3 to $V_{DD} + .3$	V
$T_{STG}$	Storage Temperature range	-65 to +150	°C
$T_J$	Maximum junction temperature	+175	°C
$T_{LS}$	Lead temperature (soldering 5 seconds)	+300	°C
$\Theta_{JC}$	Thermal resistance junction to case	20	°C/W
$I_I$	DC input current	±10	mA
$P_D$	Maximum power dissipation	1	W

### Note:

- 1) Stresses outside the listed absolute maximum ratings may cause permanent damage to the device. This is a stress rating only, functional operation of the device at these or any other conditions beyond limits indicated in the operational sections is not recommended. Exposure to absolute maximum rating conditions for extended periods may affect device reliability.

## Recommended Operating Conditions

Symbol	Parameter	Limit	Units
$V_{DD}$	Supply voltage	4.5 to 5.5	V
$V_{IN}$	Input voltage any pin	0 to $V_{DD}$	V
$T_C$	Temperature range	-55 to + 125	°C

# UT54ACS157/UT54ACTS157

## DC Electrical Characteristics <sup>7</sup>

( $V_{DD} = 5.0V \pm 10\%$ ;  $V_{SS} = 0V$  <sup>6</sup>,  $-55^{\circ}C < T_C < +125^{\circ}C$ ); Unless otherwise noted,  $T_C$  is per the temperature range ordered.

Symbol	Parameter	Condition	MIN	MAX	Unit
$V_{IL}$	Low-level input voltage <sup>1</sup> ACTS ACS			0.8 .3 $V_{DD}$	V
$V_{IH}$	High-level input voltage <sup>1</sup> ACTS ACS		.5 $V_{DD}$ .7 $V_{DD}$		V
$I_{IN}$	Input leakage current ACTS/ACS	$V_{IN} = V_{DD}$ or $V_{SS}$	-1	1	$\mu A$
$V_{OL}$	Low-level output voltage <sup>3</sup> ACTS ACS	$I_{OL} = 8.0mA$ $I_{OL} = 100\mu A$		0.40 0.25	V
$V_{OH}$	High-level output voltage <sup>3</sup> ACTS ACS	$I_{OH} = -8.0mA$ $I_{OH} = -100\mu A$	.7 $V_{DD}$ $V_{DD}-0.25$		V
$I_{OS}$	Short-circuit output current <sup>2, 4</sup> ACTS/ACS	$V_O = V_{DD}$ and $V_{SS}$	-200	200	mA
$I_{OL}$	Output current <sup>10</sup> (Sink)	$V_{IN} = V_{DD}$ or $V_{SS}$ $V_{OL} = 0.4V$	8		mA
$I_{OH}$	Output current <sup>10</sup> (Source)	$V_{IN} = V_{DD}$ or $V_{SS}$ $V_{OH} = V_{DD} - 0.4V$	-8		mA
$P_{total}$	Power dissipation <sup>2, 8, 9</sup>	$C_L = 50pF$		1.9	mW/ MHz
$I_{DDQ}$	Quiescent Supply Current	$V_{DD} = 5.5V$		10	$\mu A$
$\Delta I_{DDQ}$	Quiescent Supply Current Delta ACTS	For input under test $V_{IN} = V_{DD} - 2.1V$ For all other inputs $V_{IN} = V_{DD}$ or $V_{SS}$ $V_{DD} = 5.5V$		1.6	mA
$C_{IN}$	Input capacitance <sup>5</sup>	$f = 1MHz @ 0V$		15	pF
$C_{OUT}$	Output capacitance <sup>5</sup>	$f = 1MHz @ 0V$		15	pF

### Notes:

- Functional tests are conducted in accordance with MIL-STD-883 with the following input test conditions:  $V_{IH} = V_{IH}(\min) + 20\%$ ,  $-0\%$ ;  $V_{IL} = V_{IL}(\max) + 0\%$ ,  $-50\%$ , as specified herein, for TTL, CMOS, or Schmitt compatible inputs. Devices may be

# UT54ACS157/UT54ACTS157

tested using any input voltage within the above specified range, but are guaranteed to  $V_{IH}(\min)$  and  $V_{IL}(\max)$ .

- 2) Supplied as a design limit but not guaranteed or tested.
- 3) Per MIL-PRF-38535, for current density  $\leq 5.0E5$  amps/cm<sup>2</sup>, the maximum product of load capacitance (per output buffer) times frequency should not exceed 3,765pF/MHz.
- 4) Not more than one output may be shorted at a time for maximum duration of one second.
- 5) Capacitance measured for initial qualification and when design changes may affect the value. Capacitance is measured between the designated terminal and  $V_{SS}$  at frequency of 1MHz and a signal amplitude of 50mV rms maximum.
- 6) Maximum allowable relative shift equals 50mV.
- 7) All specifications valid for radiation dose  $\leq 1E6$  rads(Si).
- 8) Power does not include power contribution of any TTL output sink current.
- 9) Power dissipation specified per switching output.
- 10) This value is guaranteed based on characterization data, but not tested.

## AC Electrical Characteristics <sup>2</sup>

( $V_{DD} = 5.0V \pm 10\%$ ;  $V_{SS} = 0V$  <sup>1</sup>,  $-55^{\circ}C < T_C < +125^{\circ}C$ ); Unless otherwise noted,  $T_C$  is per the temperature range ordered.

Symbol	Parameter	Minimum	Maximum	Unit
$t_{PHL}$	Data to output Yn	2	15	ns
$t_{PLH}$	Data to output Yn	2	13	ns
$t_{PHL}$	Strobe to output Yn	2	15	ns
$t_{PLH}$	Strobe to output Yn	2	12	ns
$t_{PHL}$	Select to output Yn	2	16	ns
$t_{PLH}$	Select to output Yn	2	14	ns

### Notes:

- 1) Maximum allowable relative shift equals 50mV.
- 2) All specifications valid for radiation dose  $\leq 1E6$  rads(Si).

Quadruple 2 to 1 Multiplexers

# UT54ACS157/UT54ACTS157

## Packaging

### Side-Brazed Packages

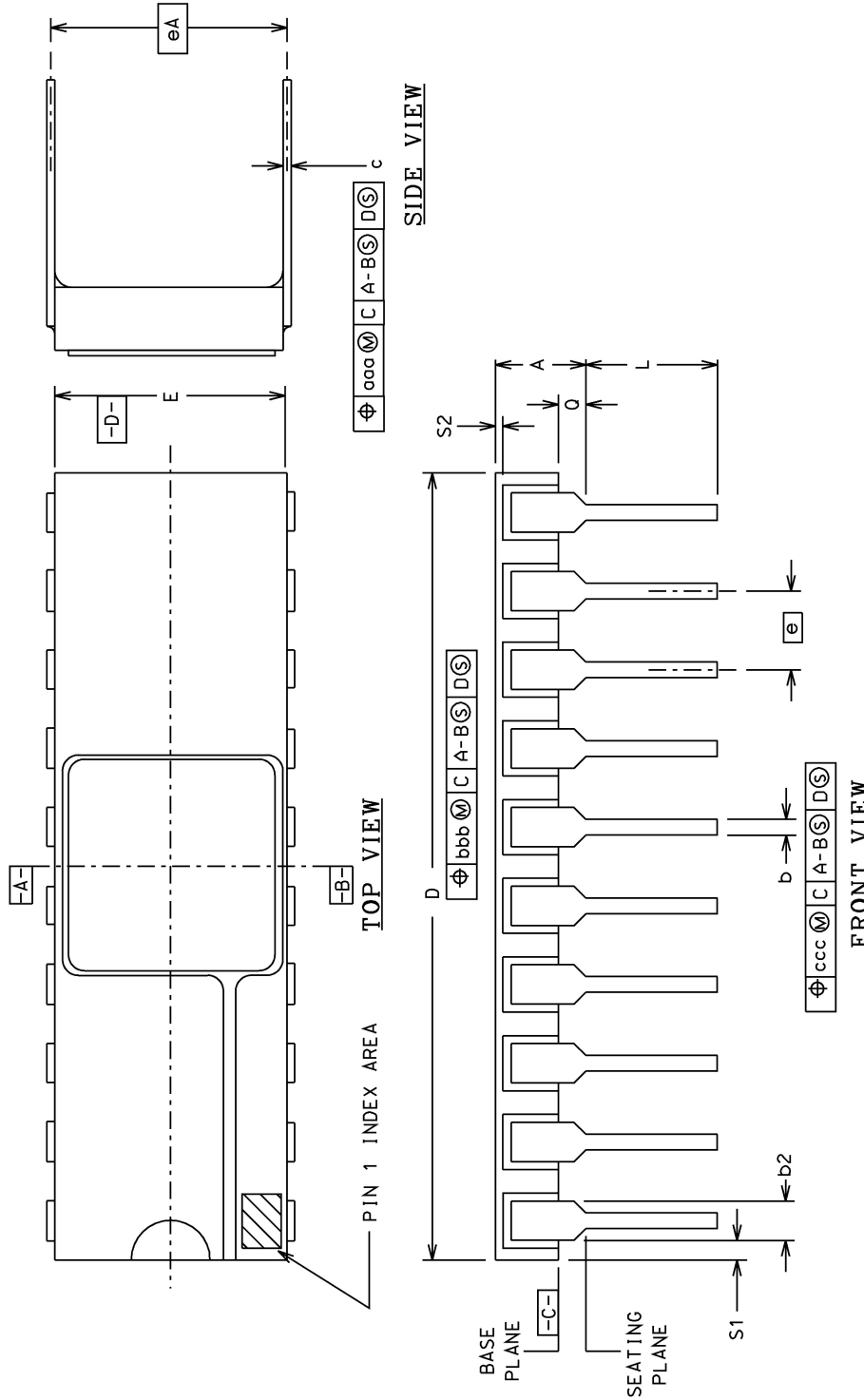

PKG CONFIG	MIL-STD- 1835 DWG CONF C	DIMENSION SYMBOLS															
		LEAD COUNT	A	b	b2	c	D	E	e	eA	L	O	S1	S2	ooo	bbb	ccc
-01	D-1	14	0.200	0.026	0.065	0.018	0.785	0.310	0.100	0.300	0.200	0.060	---	---	0.015	0.030	0.010
-02	D-2	16	0.200	0.026	0.065	0.018	0.840	0.310	0.100	0.300	0.200	0.060	---	---	0.015	0.030	0.010
-03	D-8	20	0.200	0.026	0.065	0.018	1.060	0.310	0.100	0.300	0.200	0.070	---	---	0.015	0.030	0.010
			---	0.014	0.045	0.008	---	0.220	BSC	BSC	0.125	0.015	0.005	---	---	---	---

Quadruple 2 to 1 Multiplexers

# UT54ACS157/UT54ACTS157

## Flatpack Packages

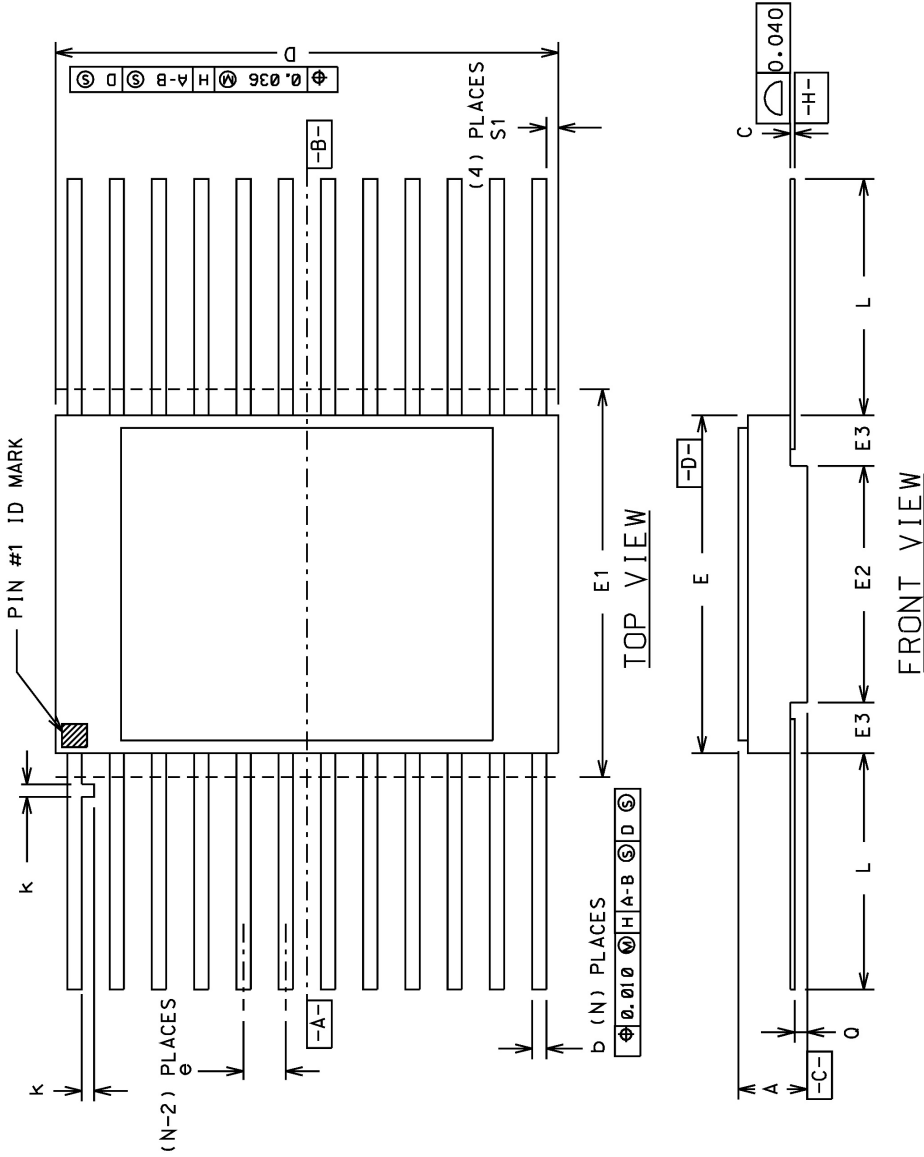

PKG CONFIG	LEAD COUNT	MIL-STD 1835 DWG CONF B	DIMENSION SYMBOLS												
			A	b	c	D	E	E1	E2	E3	e	k	L	Q	S1
-03	14	F-2A	0.115	0.022	0.009	0.390	0.260	0.290	0.130	0.050	0.015	0.370	0.045	0.005	
			0.045	0.015	0.004	---	0.235	---	0.030	BSC	0.008	0.270	0.026	---	
-04	16	F-5A	0.115	0.022	0.009	0.440	0.285	0.315	0.130	0.050	0.015	0.370	0.045	0.005	
			0.045	0.015	0.004	---	0.245	---	0.030	BSC	0.008	0.250	0.026	---	
-05	20	F-9A	0.115	0.022	0.009	0.540	0.300	0.330	0.130	0.050	0.015	0.370	0.045	0.005	
			0.045	0.015	0.004	---	0.245	---	0.030	BSC	0.008	0.250	0.026	0.000	



# UT54ACS157/UT54ACTS157

## UT54ACS157/UT54ACTS157: SMD

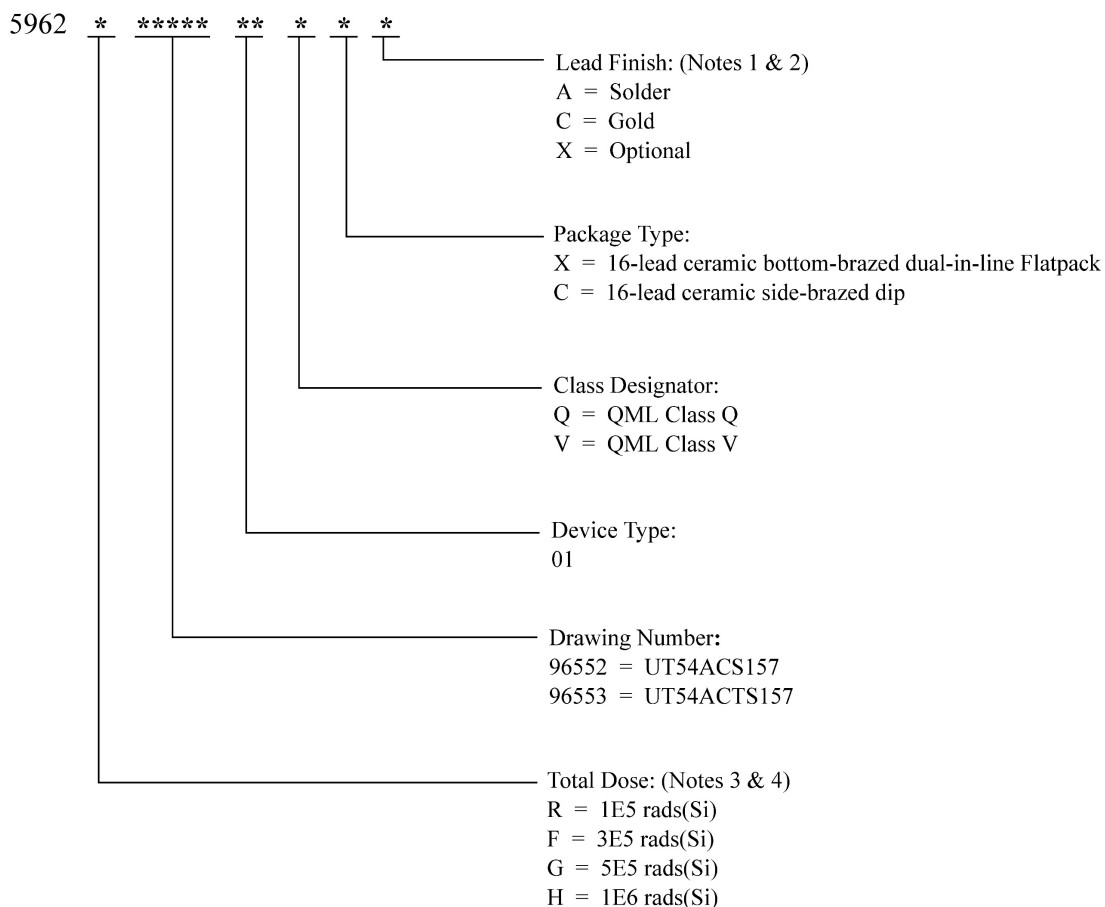

**Notes:**

- 1) Lead finish (A,C, or X) must be specified.
- 2) If an "X" is specified when ordering, part marking will match the lead finish and will be either "A" (solder) or "C" (gold).
- 3) Total dose radiation must be specified when ordering. QML Q and QML V not available without radiation hardening. For prototype inquiries, contact factory.
- 4) Device type 02 is only offered with a TID tolerance guarantee of 3E5 rads(Si) or 1E6 rads(Si) and is tested in accordance with MIL-STD-883 Test Method 1019 Condition A and section 3.11.2. Device type 03 is only offered with a TID tolerance guarantee of 1E5 rads(Si), 3E5 rads(Si), and 5E5 rads(Si), and is tested in accordance with MIL-STD-883 Test Method 1019 Condition A.

# UT54ACS157/UT54ACTS157

## Datasheet Definitions

	DEFINITION
Advanced Datasheet	CAES reserves the right to make changes to any products and services described herein at any time without notice. The product is still in the development stage and the datasheet <b>is subject to change</b> . Specifications can be <b>TBD</b> and the part package and pinout are <b>not final</b> .
Preliminary Datasheet	CAES reserves the right to make changes to any products and services described herein at any time without notice. The product is in the characterization stage and prototypes are available.
Datasheet	Product is in production and any changes to the product and services described herein will follow a formal customer notification process for form, fit or function changes.

The following United States (U.S.) Department of Commerce statement shall be applicable if these commodities, technology, or software are exported from the U.S.: These commodities, technology, or software were exported from the United States in accordance with the Export Administration Regulations. Diversion contrary to U.S. law is prohibited.

Cobham Colorado Springs Inc. d/b/a Cobham Advanced Electronic Solutions (CAES) reserves the right to make changes to any products and services described herein at any time without notice. Consult an authorized sales representative to verify that the information in this data sheet is current before using this product. The company does not assume any responsibility or liability arising out of the application or use of any product or service described herein, except as expressly agreed to in writing; nor does the purchase, lease, or use of a product or service convey a license under any patent rights, copyrights, trademark rights, or any other of the intellectual rights of the company or of third parties.